



BRIEF INFORMATION

Innovative side marker, position and clearance lamp

- For 12 and 24 volt applications
- High level of safety thanks to maximum illuminated area
- Modern night design ("glowing edges")

PRODUCT CHARACTERISTICS

Contacting

In addition to the 6.3 contact pin, the customer can choose from two further connections. A version with AMP plug also allows the light to be used in wet outdoor areas. A potted cable version rounds off the contacting options.

Seal to the vehicle

Unless glued in place, a microcellular rubber seal can be used to seal the light to the vehicle.

Night design

Especially on the side of the vehicle, the design is emphasised by the striking and extensive illumination and follows the current trend in the automotive industry of giving lighting elements a stylish appearance, particularly in their night design.

A complete product line

Alongside the 12 V and 24 V versions, position lights (PO) and clearance lamps (UR) in matching design are also available. Coloured frames in white, orange, grey and black complete the range. The light fits in well with all vehicle designs.

State-of-the-art production engineering

The frame is "injected" around the housing and the lens. This significantly increases air-tightness compared with conventional welding or gluing methods.

Time and cost-optimised assembly

Fast and safe installation is achieved by using a 6.3 contact pin. The round connector skirt is also used as a positioning aid and to protect the contact lugs. A loop-through can be realised using double crimping. The side marker lamp can be installed both in a horizontal or vertical position.

LED LIGHTING TECHNOLOGY

As a leading innovator in the field of automotive original equipment, HELLA is setting benchmarks:

Extremely low energy consumption

By combining efficient LEDs with precision lenses, Hella lights achieve the light distribution specified by law – while using up to 80 % less power than filament bulbs!

No change of light source, no maintenance and an extremely long operating time thanks to optimal thermal management.

To extend the service life of the light, the components are arranged in a way that optimises the temperature conditions, preventing overheating of the LEDs at extremely high temperatures. This thermal management boosts the service life to a maximum – even under adverse application conditions. Depending on environmental conditions, 30,000 hours and more can be achieved.

MAXIMISING SAFETY

Attractive night design

The large-area, homogeneous illumination of the whole lens from all viewing angles results in optimum visibility and thus maximum safety. New "glowing edges" technology emphasise all contours of the light, generating an impressive, innovative night design for side marker, position and clearance light functions.

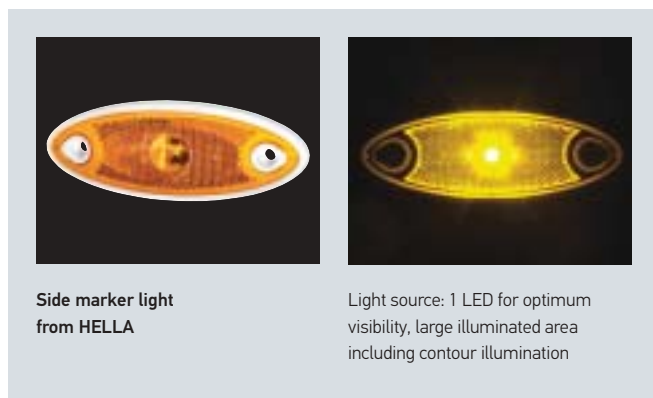

The image shows two side-by-side comparisons of side marker lights. On the left is the Hella light, which is shown as a physical component and as a glowing yellow light with a large, uniform, oval-shaped illumination area. On the right is a competitor's light, shown as a physical component and as a glowing light with a much smaller, more concentrated, and less uniform illumination area.

Side marker light from HELLA

Light source: 1 LED for optimum visibility, large illuminated area including contour illumination



The image shows two side-by-side comparisons of competitor's light. On the left is the competitor's light, shown as a physical component and as a glowing light with a small, concentrated, and less uniform illumination area. On the right is the Hella light, shown as a physical component and as a glowing light with a large, uniform, oval-shaped illumination area.

Competitor's light

Light source: 1 LED minimum, spotlight area

STATE-OF-THE-ART PRODUCTION ENGINEERING

What we're proud of and work on every day



We have established a commitment to quality in our corporate culture: every day, we drive forward improvements to our production processes and the objective of customer line returns of 2 ppm a year.

Process reliability

Fully automated production guarantees a high degree of quality in terms of air-tightness and fault rate. Process faults are excluded, from injection moulding through testing to packaging.

TECHNICAL DETAILS

Technical specifications

Type approval*	ECE  5853
Operating voltage	12 V and 24 V
EMC approval	 03 0227
Functions	Side marker light Position light Clearance lamp
Number of LEDs	1
Power consumption	0.5 W/12 V 1.0 W/24 V
Dimensions (W x H x D) Plug Cable versions	147 x 54 x 27.5 147 x 54 x 14.7
Operating temperature	-40 °C to +50 °C
Protection class	IP 6K9K
Contacts	6.3 mm blade terminal or Open cable end or AMP Superseal
Installation	Screw connection with 2 screws \varnothing 6 mm
Specification	HELLA standard 67001, class 10 Maximum specification
Design life	30,000 h**

* SAE certification available as required

** Dependent upon the operating temperature

Technical drawing

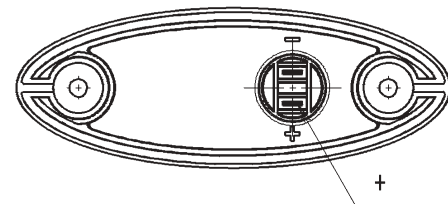
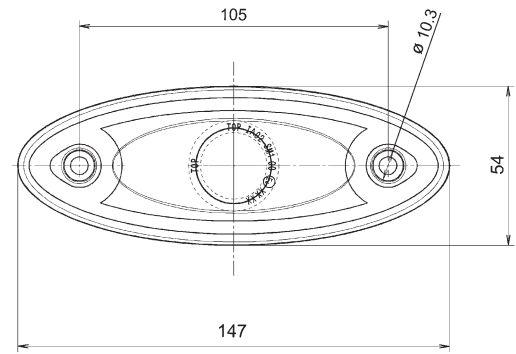

Hole pattern for 6.3 mm contact

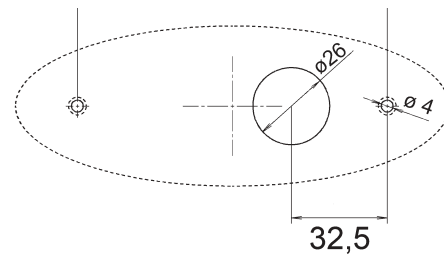

Hole pattern for AMP Superseal

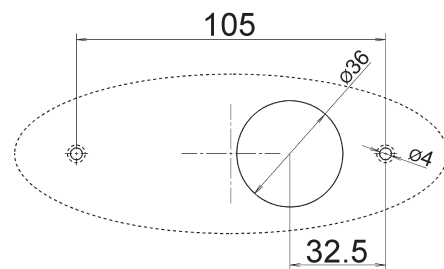

APPLICATION EXAMPLE



with 6.3 mm contact

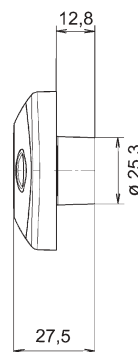



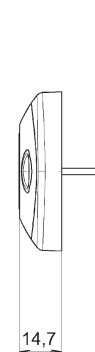



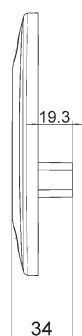

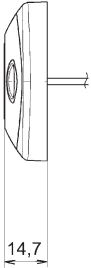

with cable



AMP Superseal

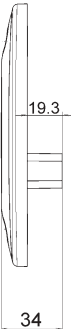

RANGE OVERVIEW

Technical drawing	Product image	Part number*	Connection	Voltage	Installation		Housing Colour	Packaging unit**
					Hor.	Vert.		
		2PG 344 690-301	500 mm cable	12 V	X		□	1
		2TM 344 690-351	500 mm cable	12 V	X		■	1
		2PS 344 690-001	6.3 mm contacts	12 V	X	X	□	1
		2PS 344 690-021	6.3 mm contacts	12 V	X	X	■	1
		2PS 344 690-061	6.3 mm contacts	12 V	X	X	■	1
		2PS 344 690-031	6.3 mm contacts	24 V	X	X	■	1
		2PS 344 690-601	AMP-Superseal	12 V	X	X		1
		2PS 344 690-611	AMP-Superseal	12 V	X	X	■	1
		2PS 344 690-681	AMP-Superseal	24 V	X	X	■	1
		2PS 344 690-621	AMP-Superseal	24 V	X	X	■	1

* With ECE type approval
 ** VPE 7 available upon request

Accessories

Rubber seal	9GD 343 697-007
Grommet	9GT 343 367-002